

Datasheet

Small Sized, Seven Color Indicator with Flashing Input Control

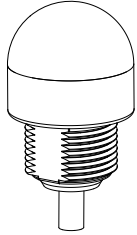

- Bright, uniform indicator light
- Seven colors in one device (Red, Yellow, Green, Cyan, Blue, Magenta, White)
- 22 mm threaded polycarbonate base
- Translucent polycarbonate dome
- Rugged IP66, IP67, IP69K, and UL Type 4X, 13 design
- Bimodal inputs (PNP/NPN, depending on source wiring)
- All models have flashing input control
- Variety of connector options
- Models constructed from FDA-grade materials available

Models

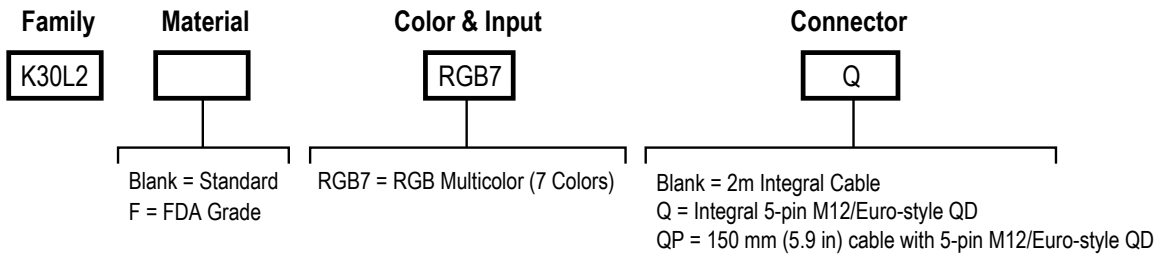

Wiring Diagrams

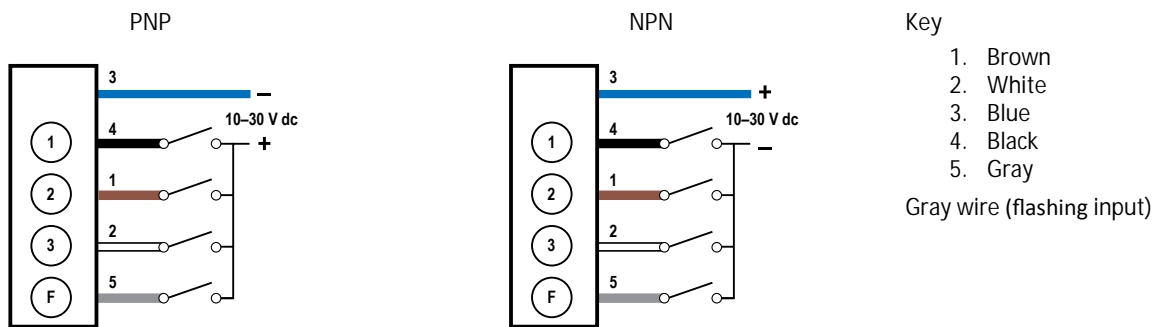

Table 1: Color Definition

	Red	Yellow	Green	Cyan	Blue	Magenta	White
Input 1	X	X				X	X
Input 2		X	X	X			X
Input 3				X	X	X	X

An "X" denotes an active input, for example when Input 1 and Input 3 are active, the indicator will show Magenta.



Specifications

Supply Voltage and Current

- 10 V dc to 30 V dc
- 60 mA Max at 10 V dc
 - 50 mA Max. at 12 V dc
 - 35 mA Max. at 24 V dc
 - 30 mA Max. at 30 V dc

Supply Protection

Protected against reverse polarity and transient voltages

Input Response Time

250 ms maximum

Flash

1.5 Hz flash rate through flash input wire

Construction

Standard model base, dome, and nut: polycarbonate
FDA model base, dome, and nut: FDA grade polycarbonate

Connections

Integral 5-pin M12/Euro-style quick disconnect, or 150 mm (6 in) PVC cable with quick disconnect, or 2 m (6.5 ft) cable, depending on model

Mounting

M22 by 1.5 threaded base, max torque 2.25 Nm (20 in-lbf)
Mounting nut included

Indicators

7 colors
Only one color can be on at a time.

Indicator Characteristics

Color	Dominant Wavelength (nm) or Color Temperature (CCT)	Color Coordinates ¹		Lumen Output (Typical at 25 °C)
		X	Y	
Green	528 nm	0.184	0.707	4.6
Red	625 nm	0.693	0.305	3.2
Blue	470 nm	0.147	0.041	0.7
White	5700 K	0.319	0.333	6.9
Yellow	–	0.449	0.474	7.1
Cyan	–	0.194	0.331	5.3
Magenta	–	0.370	0.179	4.5

Environmental Rating

Standard models: IEC IP66, IEC IP67, IEC IP69K per DIN 40050-6, UL Type 4X, 13
FDA models: IEC IP66, IEC IP67, IEC IP69K per DIN 40050-6

Vibration and Mechanical Shock

All models meet Mil Std. 202F requirements. Method 201A (vibration: 10 Hz to 60 Hz max., double amplitude 0.06 inch, maximum acceleration 10G). Also meets IEC 60947-5-1 requirements: 15G 11 ms duration, half sine wave.

Operating Conditions

–40 °C to +50 °C (–40 °F to +122 °F)
90% at +50 °C maximum relative humidity (non-condensing)
Storage Temperature: –40 °C to +70 °C (–40 °F to +158 °F)

Required Overcurrent Protection



WARNING: Electrical connections must be made by qualified personnel in accordance with local and national electrical codes and regulations.

Overcurrent protection is required to be provided by end product application per the supplied table.

Overcurrent protection may be provided with external fusing or via Current Limiting, Class 2 Power Supply.

Supply wiring leads < 24 AWG shall not be spliced.

For additional product support, go to www.bannerengineering.com.

Supply Wiring (AWG)	Required Overcurrent Protection (Amps)
20	5.0
22	3.0
24	2.0
26	1.0
28	0.8
30	0.5

Certifications



Dimensions

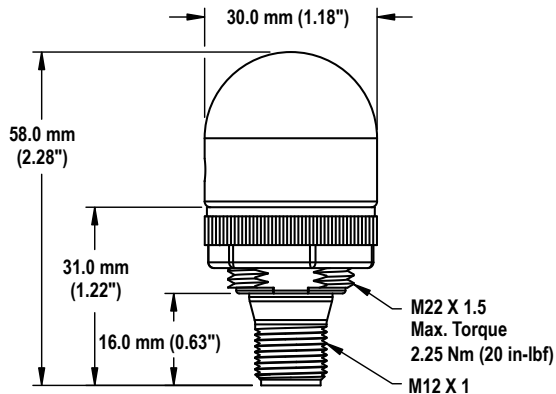

¹ Refer to CIE 1931 chromaticity diagram or color chart, to show equivalent color with indicated color coordinates.

Accessories

Cordsets

5-Pin Threaded M12/Euro-Style Cordsets—Single Ended				
Model	Length	Style	Dimensions	Pinout (Female)
MQDC1-501.5	0.50 m (1.5 ft)	Straight		<p>1 = Brown 2 = White 3 = Blue 4 = Black 5 = Gray</p>
MQDC1-506	1.83 m (6 ft)			
MQDC1-515	4.57 m (15 ft)			
MQDC1-530	9.14 m (30 ft)			
MQDC1-506RA	1.83 m (6 ft)	Right-Angle		
MQDC1-515RA	4.57 m (15 ft)			
MQDC1-530RA	9.14 m (30 ft)			

5-Pin Threaded M12/Euro-Style Cordsets—Washdown, with Shield				
Model	Length	Style	Dimensions	Pinout (Female)
MQDCWD-506	1.83 m (6 ft)	Straight		<p>1 = Brown 2 = White 3 = Blue 4 = Black 5 = Gray</p>
MQDCWD-530	9.14 m (30 ft)			

Brackets

SMB22A

- Right-angle bracket with curved slot for versatile orientation
- 12-ga. stainless steel
- Mounting hole for 22 mm sensor

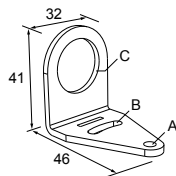

Hole center spacing: A to B = 26.0

Hole size: A = \varnothing 4.6, B = 4.6 x 16.9, C = 22.2

SMB22FVK

- V-clamp, flat bracket and fasteners for mounting to pipe or extensions
- Clamp accommodates 28 mm diameter tubing or 1 in. square extrusions
- 22 mm hole for mounting sensor

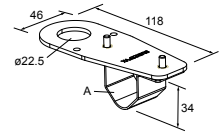

Hole size: A = \varnothing 22.5

SMB22RAVK

- V-clamp, right-angle bracket and fasteners for mounting to pipe or extensions
- Clamp accommodates 28 mm diameter tubing or 1 in. square extrusions
- 22 mm hole for mounting sensor

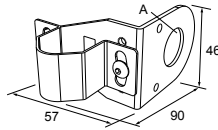

Hole size: A = \varnothing 22.5

SMBAMS22P

- Flat SMBAMS series bracket with 22 mm hole for mounting sensors
- Articulation slots for 90+° rotation
- 12-ga. (2.6 mm) cold-rolled steel

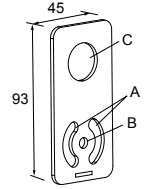

Hole center spacing: A = 26.0, A to B = 13.0

Hole size: A = 26.8 x 7.0, B = \varnothing 6.5, C = \varnothing 22.5

SMBAMS22RA

- Right-angle SMBAMS series bracket with 22 mm hole for mounting sensors
- Articulation slots for 90+° rotation
- 12-ga. (2.6 mm) cold-rolled steel

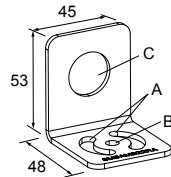

Hole center spacing: A = 26.0, A to B = 13.0

Hole size: A = 26.8 x 7.0, B = \varnothing 6.5, C = \varnothing 22.5

Banner Engineering Corp. Limited Warranty

Banner Engineering Corp. warrants its products to be free from defects in material and workmanship for one year following the date of shipment. Banner Engineering Corp. will repair or replace, free of charge, any product of its manufacture which, at the time it is returned to the factory, is found to have been defective during the warranty period. This warranty does not cover damage or liability for misuse, abuse, or the improper application or installation of the Banner product.

THIS LIMITED WARRANTY IS EXCLUSIVE AND IN LIEU OF ALL OTHER WARRANTIES WHETHER EXPRESS OR IMPLIED (INCLUDING, WITHOUT LIMITATION, ANY WARRANTY OF MERCHANTABILITY OR FITNESS FOR A PARTICULAR PURPOSE), AND WHETHER ARISING UNDER COURSE OF PERFORMANCE, COURSE OF DEALING OR TRADE USAGE.

This Warranty is exclusive and limited to repair or, at the discretion of Banner Engineering Corp., replacement. IN NO EVENT SHALL BANNER ENGINEERING CORP. BE LIABLE TO BUYER OR ANY OTHER PERSON OR ENTITY FOR ANY EXTRA COSTS, EXPENSES, LOSSES, LOSS OF PROFITS, OR ANY INCIDENTAL, CONSEQUENTIAL OR SPECIAL DAMAGES RESULTING FROM ANY PRODUCT DEFECT OR FROM THE USE OR INABILITY TO USE THE PRODUCT, WHETHER ARISING IN CONTRACT OR WARRANTY, STATUTE, TORT, STRICT LIABILITY, NEGLIGENCE, OR OTHERWISE.

Banner Engineering Corp. reserves the right to change, modify or improve the design of the product without assuming any obligations or liabilities relating to any product previously manufactured by Banner Engineering Corp. Any misuse, abuse, or improper application or installation of this product or use of the product for personal protection applications when the product is identified as not intended for such purposes will void the product warranty. Any modifications to this product without prior express approval by Banner Engineering Corp will void the product warranties. All specifications published in this document are subject to change; Banner reserves the right to modify product specifications or update documentation at any time. Specifications and product information in English supersede that which is provided in any other language. For the most recent version of any documentation, refer to:

www.bannerengineering.com.